

PD30 - IO-Link smart photoelectric sensors

Sensors

PD30 series

IO-Link smart photoelectric sensors

The PD30 IO-Link smart sensors are highly flexible multifunction sensors in a compact housing.

The PD30 IO-Link smart sensors offer: Background suppression, Foreground suppression, PointSpot versions with sensing distances up to 350 mm. Diffuse reflective variants with IR- or Red emitter and 1 m sensing distance and Retro-reflective sensors with Polarized- or PointSpot light source with sensing distance up to 6 m.

The PD30 IO-Link smart sensors have besides the many other fantastic IO-Link options also 4 unique application functions: Speed and length, Pattern recognition, Divider and Object and gap monitoring.

The PD30 IO-Link smart sensors are available in two housing styles, an AISI316L stainless steel version with IP69K and ECOLAB approvals designed for use in harsh or hygienic environments and an ABS plastic version with IP 67 approval.



Universal, smart and easy



Data availability down to the field level

Using IO-Link, the sensors can deliver their data directly into the control system very efficiently.

Device identification

Each IO-Link sensor has an IODD (IO Device Description), which describes the sensor, its capabilities and parameters, process data, diagnosis data and user interface configuration. Furthermore, each sensor is equipped with an internal ID.

Automatic parameter settings

Initial setup of a new sensor is smooth and easy using previously stored parameters. Once a sensor has been replaced, the IO-Link master simply transmits parameters stored from the old sensor.

Centralized configuration and data management

IO-Link enables fast configuration and dynamic change of the sensor parameters on the fly, which considerably reduces downtime in case of product changeover and increases flexibility and diversity of the installation.

Universal, smart and easy

Simplified installation

An IO-Link system requires just standard, unshielded 3-wire cables, and a standardized uniform interface for sensors and actuators drastically reduces the complexity of the installation process. In addition, the automated parameter reassignment simplifies sensor replacement in case of defects and prevents incorrect settings. The IO-Link-enabled sensor acts as a standard sensor when installed in a non-IO-Link system, so the same sensor can be

stocked for both standard I/O (SIO) applications and IO-Link applications.

Simplified configuration with the Handheld IO-Link SCTL55 smart configurator

By using the Handheld IO-Link SCTL55 smart configurator from Carlo Gavazzi it is very smart and easy to configure your IO-Link sensor. When the SCTL55 smart configurator has automatically downloaded the sensors IODD file you are ready to configure.



IO-Link

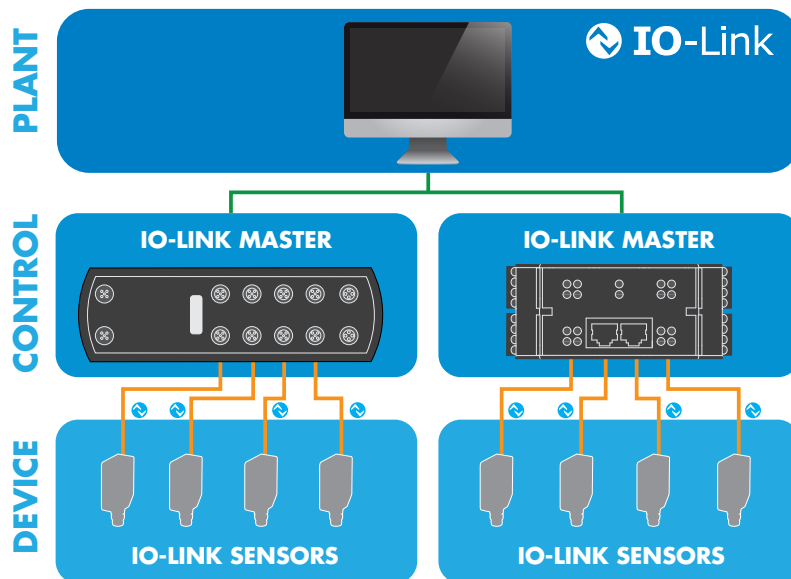

What is IO-Link?

IO-Link is a universal, open communication standard protocol that allows IO-Link-enabled devices to exchange, collect and analyze data and convert it into actionable information.

IO-Link is recognized worldwide as an international standard (IEC 61131-9), and it is today considered as the "USB interface" for sensors and actuators in the industrial automation environment.

Plug and play

When the IO-Link sensor is connected to an IO-Link port, the IO-Link master sends a wake-up request to the sensor, which automatically switches to IO-Link mode, and a point-to-point bidirectional communication automatically starts between the master and the sensor.

Operating modes

The IO-Link-capable sensor can operate in two different modes; SIO mode (standard I/O) or IO-Link mode.

- SIO mode: the sensor works as a traditional sensor, and pin 4 acts as an ordinary digital output. SIO mode ensures backwards compatibility with standard sensor systems.
- IO-Link mode: exchange of data between sensor and IO-Link master takes place, and pin 4 is used for the transmission of IO-Link-related data.

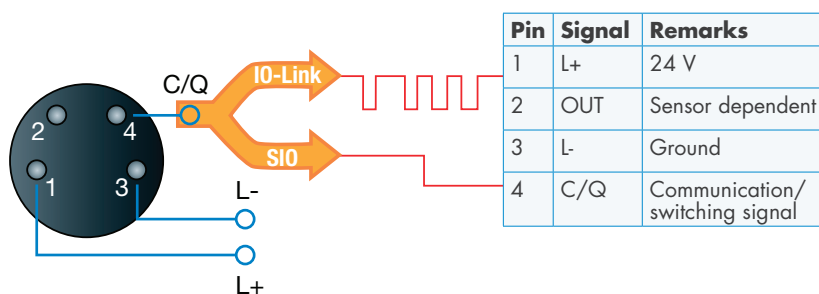

Pin	Signal	Remarks
1	L+	24 V
2	OUT	Sensor dependent
3	L-	Ground
4	C/Q	Communication/switching signal

PD30 series

IO-Link smart photoelectric sensors

IO-Link functions

Highly flexible sensors

IO-Link provides the first globally standardized interface for communication with the sensor. Once you have connected the sensor to the IO-Link port, you can access a multitude of configuration parameters and advanced functionalities. This way, the sensor can be tailored to meet your individual needs and requirements at a given time. The settings can also be stored in a master and can always be changed if the need occurs, or they can be smoothly transferred to a new sensor in case of sensor replacement.

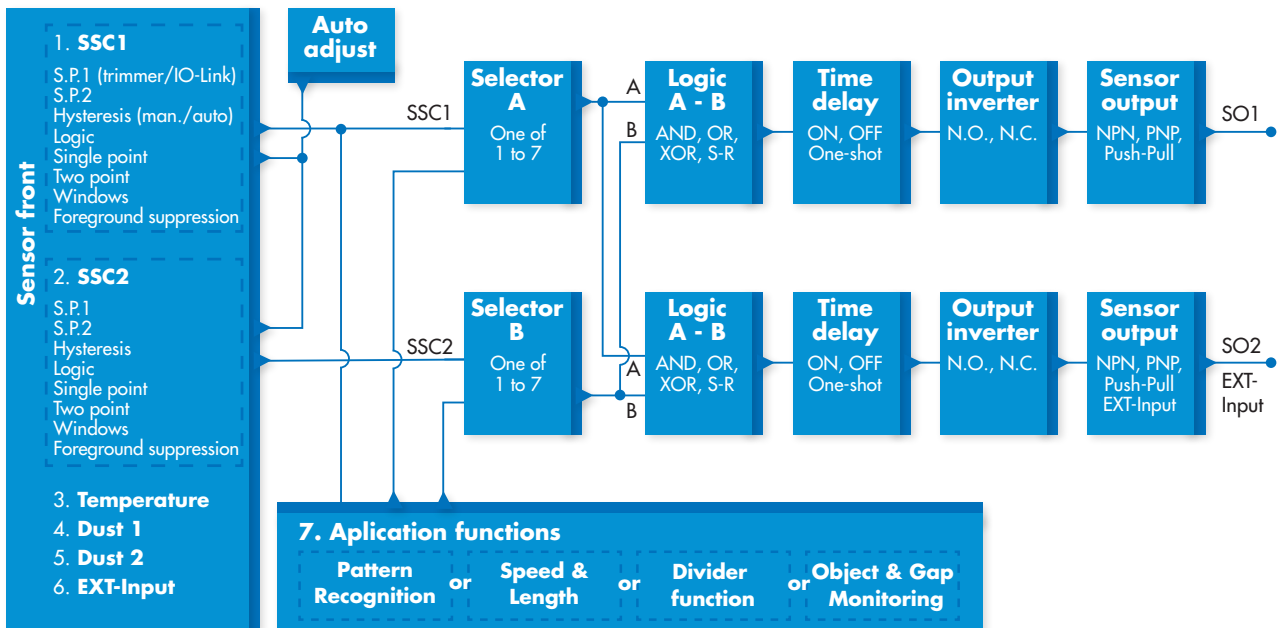

Sensor front

The Diffuse Reflective sensor emits light towards a target and measures the light level reflected from the target.

The (Polarized) Retro-reflective sensor emits light towards a target (Corner cube reflector) and measures the light level reflected from it.

The Background Suppression (BGS) sensor emits light towards a target and measure the position of the light reflected from the target.

SSC1 and SSC2 (Switching Signal Channel) Detection modes

Each SSC channel can be set and operate in 4 detection modes or be disabled. The switch point mode setting can be used to create more advanced output behavior. The following switch point modes can be selected for the switching behavior of SSC1 and SSC2.

Single-point mode, two-point mode, windows mode and Foreground suppression Mode (only BGS).

Single point mode

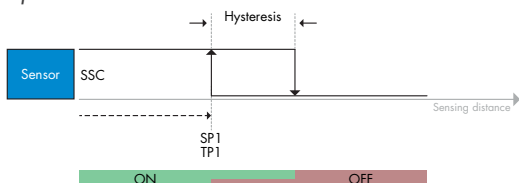

Two point mode

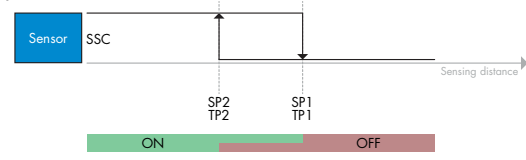

Windows mode

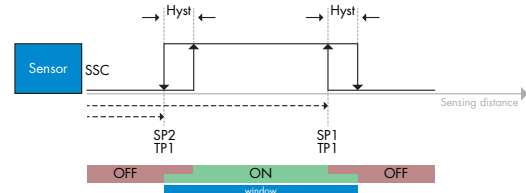

Foreground suppression mode (only BGS)

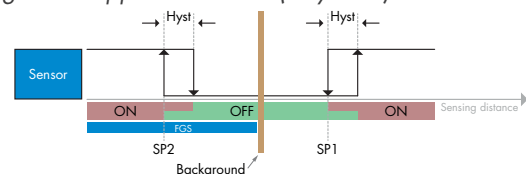

Hysteresis Settings

The hysteresis can be set automatically or manually for SSC1 and manually only for SSC2. The hysteresis is set as a percentage of the set value chosen for SP1 and SP2.

Automatic hysteresis

Automatic hysteresis will guarantee stable operation for most application.

IO-Link functions

Manual hysteresis

When manual hysteresis is selected, the hysteresis can be changed between 5 ... 99%

Temperature alarm

The sensor can be configured to give an alarm if the temperature exceeds or drops below a preset value (Tmax or Tmin).

Dust alarm 1 and Dust alarm 2

The sensor can be configured to give an alarm even with a slightly buildup of dust.

Water drop alarm 1 and Water drop alarm 2

The sensor can be configured to give an alarm even with a slightly buildup of water drops.

External input

The output 2 (SO2) can be configured as an external input allowing external signals to be fed into the sensor.

Auto adjust (not BGS sensor versions)

Auto adjustment function can be enabled to compensate for buildup of dust or water drops.

Based upon a preset setpoint from the trimmer, with IO-Link parameters SSC1_SP1 / SSC2_SP1 or by Teach, the sensor continuously monitors the received signals from the target and background, and adjusts the setpoint up or down if a stable ON or OFF state cannot be reached.

Dust alarm is activated if Auto adjust has reached its maximum sensibility and cleaning is needed.

Water drop alarm is activated if Auto adjust has reached its minimum sensibility and cleaning is needed.

Selector

This function block allows the user to select any of the signals from the "sensor front" to the Channel A or B.

Channels A and B: can select from SSC1, SSC2, Temperature alarm, Dust alarm 1, Dust alarm 2 and External input.

Logic

In the logic function block the selected signals from the input selector can be added a logic function directly without using a PLC – making decentral decisions possible.

The logic functions available are: AND, OR, XOR and Gated SR-FF.

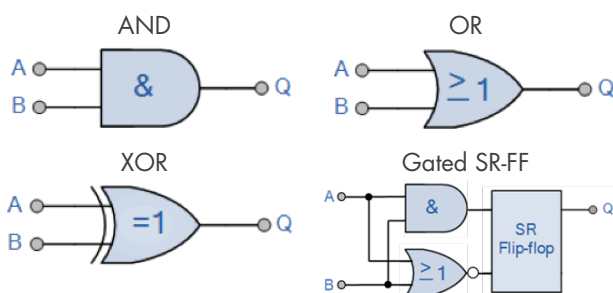

Time delay

It is possible to activate different timer functions: ON delay, OFF delay, ON and OFF delay or one shot (leading edge or trailing edge).

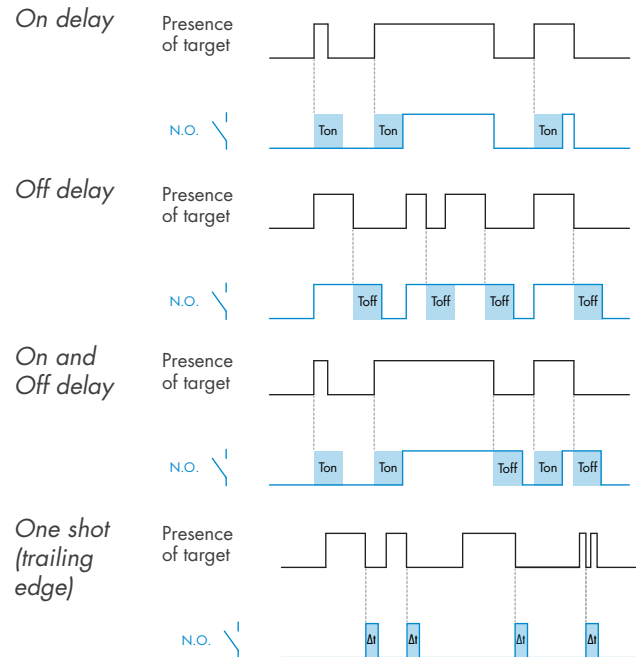

Output inverter

The output can be configured to normally open or normally closed.

Sensor output

The I/O terminals can be configured as: NPN, PNP, push-pull or external input (only output 2).

Outputs/inputs

The sensor has two I/O terminals SO1 and SO2.

Application functions

4 unique application functions can be selected via IO-Link only.

- Pattern Recognition.
- Speed and Length.
- Divider.
- Object and Gap Monitoring.

Predictive maintenance

QoR (Quality of Run) from 0 to 255%

QoT (Quality of Teach) from 0 to 255%

Operation hours, hourly data saved in sensor internal memory.

Operating cycles for SSC1, sensor logs SSC1 detections.

Power cycles, number of ON/OFF switching's of the sensor.

Dust alarm, variable safe limits from 0 ... 100%.

Temperature alarm, separate setpoints for high and low temperature alarm settings.



PD30 series

IO-Link smart photoelectric sensors

Application functions

Optimized design for applications like automatic conveyor systems or packaging machinery, the PD30 IO-Link smart sensors provides four new unique predefined and selectable application functions: Speed and length, Pattern recognition, Divider function and Object and gap monitoring. These embedded functions help the customer with additional data, decentralized controls, very important to optimize the production process, and simplification of the machine control system layout.

Pattern recognition

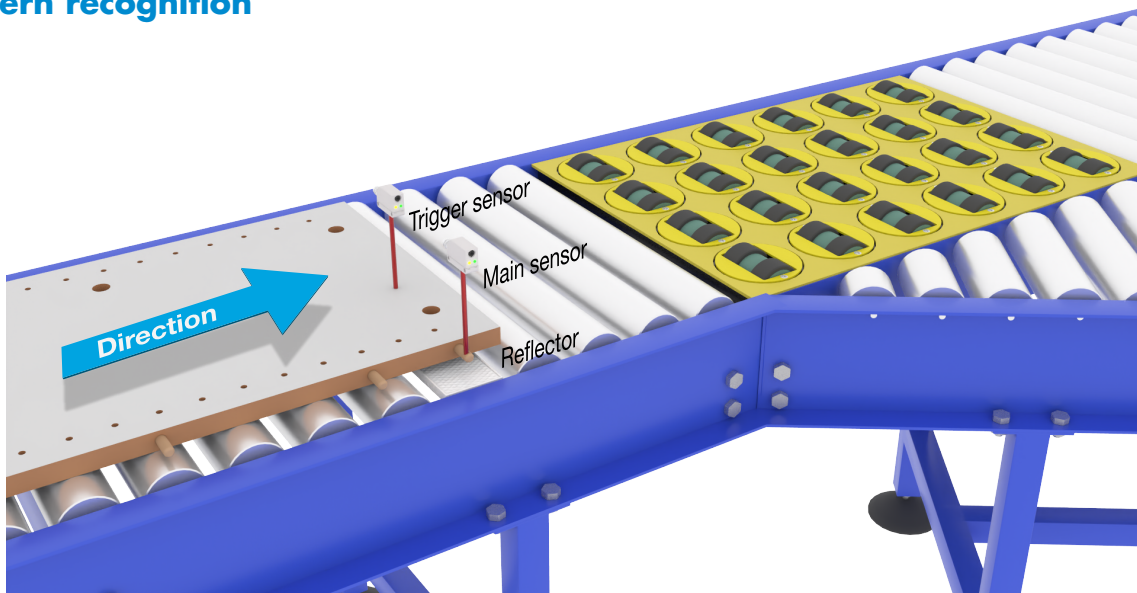

The pattern recognition function is used to verify if a manufactured part has all the e.g. holes or taps as expected and that the parts are made according to the specification.

Speed and Length

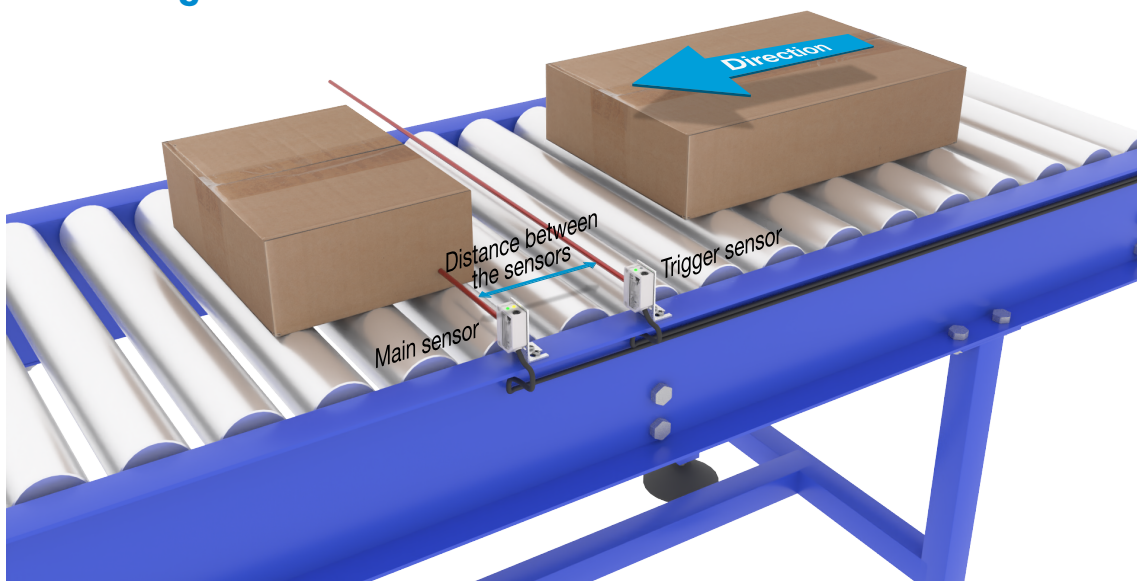

Monitor the speed and length of an object on a conveyor for e.g. sorting on size. With this unique function it is possible to monitor the speed and length of an object on a conveyor for e.g. sorting on size.

Application functions

Divider function

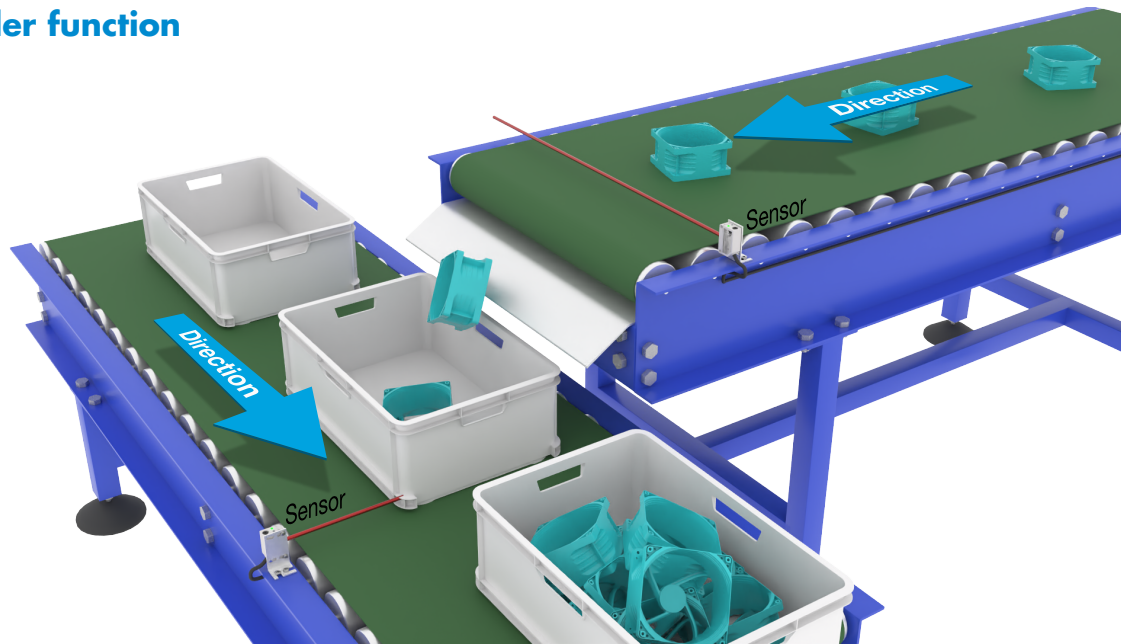

A decentral counting function that gives a signal when a preset count level is reached e.g. when a certain items are packed in a carton box it ask for a new box.

Object and Gap Monitoring

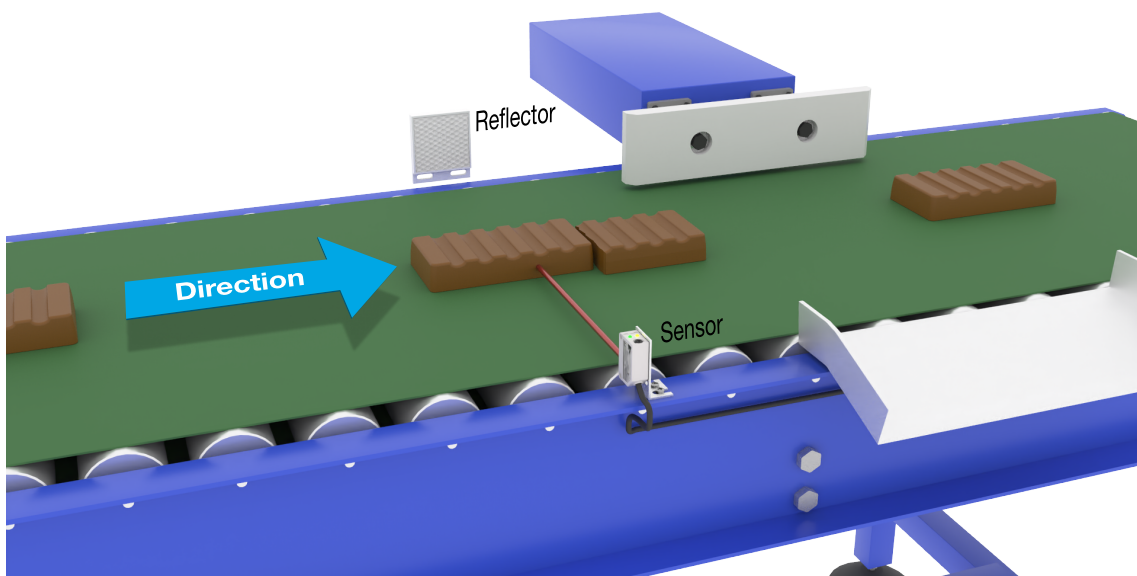

This function is designed to monitor that the length of an objects and the gap between the following object on a conveyor belt are within certain limits.

PD30 series

IO-Link smart photoelectric sensors

The sensing principle

Diffuse-Reflective

Emitter and receiver in one and the same housing. A diffuse-reflective sensor without background suppression measures only energy returned from objects, which makes it ideal for structured surfaces because the sensor detects an average amount of light reflected.



Retro-Reflective and Polarized Reflective

Emitter and receiver in one and the same housing. The signal from the emitter is sent to a reflector/passive device, and the need for wiring is reduced to one side of the application. The infrared retro-reflective sensor is primarily used in applications where the light beam must be invisible - for instance in entrance systems/doorways. The polarized reflective sensors are also able to detect objects with bright shiny surfaces.

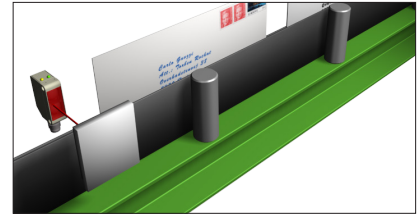

Retro-Reflective PointSpot

Emitter and receiver in one and the same housing. The signal from the emitter is sent to a reflector/passive device, and the need for wiring is reduced to one side of the application. The retro-reflective PointSpot sensor emits a highly visible and well-defined light spot without any disturbing "halo".

The polarized reflective sensors are also able to detect objects with bright shiny surfaces.

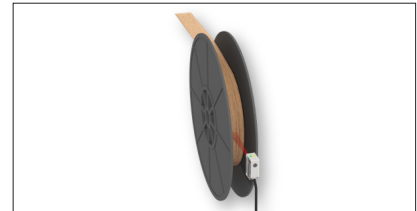

Background Suppression

A background suppression sensor detects an object using triangulation. Unlike a diffuse-reflective sensor, it is not colour-sensitive and is, therefore, capable of detecting a black object in front of, for instance, a white background.

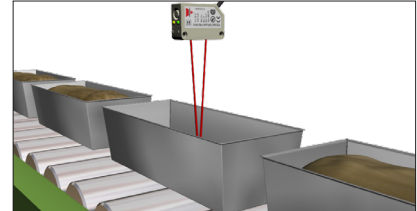

Background Suppression PointSpot

A background suppression sensor detects an object using triangulation. The background suppression PointSpot sensor has an excellent colour variation suppression (same distance on all colours). In addition, the PointSpot sensor emits no disturbing halo light but produces a well-defined, visible light spot.

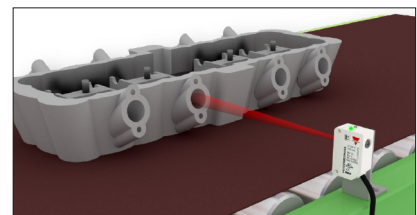

The advantages of the PD30 series in stainless steel



Highest degree of protection

The IP69K rating is for applications where high pressure and high temperature wash-down is used to sanitize equipment.

The PD30 Stainless steel housing withstands high-pressure cleaning processes with chemicals, and the sensor's object detection is continuous and reliable even in the harshest conditions. Certified by Ecolab.

PD30 photoelectric IO-Link Diffuse reflective types

Housing	Plastic (ABS)		Stainless steel (AISI316L)	
	Plug	Cable	Plug	Cable
Infrared light (850 nm)	PD30CTDI10BPM5IO	PD30CTDI10BPA2IO	PD30ETDI10BPM5IO	PD30ETDI10BPA2IO
Red light (617 nm)	PD30CTDR10BPM5IO	PD30CTDR10BPA2IO	PD30ETDR10BPM5IO	PD30ETDR10BPA2IO
Sensing distance	100 ... 1000 mm			
Rated operating distance (S _r)	≤ 1000 mm			
IO-Link	Transmission type: COM2 (38.4 k Baud), Revision: 1.1, SDCI standard: IEC 61131-9, Profiles: Smart sensor (Process Data Variable; Device Identification), SIO mode: Yes, Required master port type: A, Min. process cycle time [ms]: 5			
Selectable function output 1	NPN, PNP or Push-Pull			
Selectable function output 2	NPN, PNP, Push-Pull, External input or External teach			
Diagnostic	Operation hours, Power cycles, Detection cycles max. and min. Temperatures, Short-circuit, No of Parameter change.			
Logic functions	AND, OR, X-OR, Gated SR-FF			
Timer functions	ON Delay, OFF delay, ON+OFF delay and One shot			
Sensitivity control	Trimmer input, Teach by wire or by IO-Link			
Rated operational voltage (U _B)	10 to 30 V DC (ripple included)			
No load supply current (I _s)	≤ 30 mA @ U _B min., ≤ 15 mA @ U _B max			
Minimum operational current (I _m)	> 0.5 mA			
Off-State current (I _o)	≤ 50 µA			
Voltage drop, digital (U _d)	≤ 1.0 V DC @ 100 mA DC			
Capacitive load	100 nF @ 100 mA, 24 VDC			
Frequency of operating cycles (f)	≤ 1000 Hz			
Response time t _{ON} or t _{OFF}	≤ 500 µs			
Power on delay (t _i)	≤ 150 ms			
Hysteresis (adjustable by IO-Link)	Manual: 1 ... 100% Automatic: Typical 5% ... 10% / Max. 15%			
Led indications	Yellow LED steady: Output ON and signal stability. Yellow LED flashing: Output short-circuit, timer indication and teach. Green LED steady: Power ON and signal stability. Green LED flashing: IO-Link mode. Yellow LED and green LED flashing: Find my sensor			
Sensor protection	Short circuit (A), reverse polarity (B) and transients (C)			
Electrostatic discharge	Contact discharge: ±4 kV. Air discharge: ±8 kV (IEC 61000-4-2; EN60947-1)			
Electrical fast transients/burst	±2kV/5kHz (IEC 61000-4-4; EN60947-1)			
Surge	1kV (with 500 Ω)			
Wire conducted disturbances	10 Vrms (IEC 61000-4-6; EN60947-1)			
Power - frequency magnetic fields	30 A/m, 38 µ tesla (IEC 61000-4-8)			
Radiated RF electromagnetic fields	10 V/m (IEC 61000-4-3)			
Vibration	10 to 150 Hz, 1 mm/15G in X,Y and Z direction (EN 60068-2-6)			
Shock	30G /11 mS. 6 positive and 6 negative in X,Y and Z direction (EN 60068-2-27)			
Drop test	2 times from 1m, 100 times from 0,5m (EN 60068-2-31)			
Degree of protection	IP67 (IEC60539; EN60947-1)		IP67, IP68, IP69K (IEC60539; EN60947-1; DIN40050-9)	
NEMA type	1 (NEMA 250)		1, 2, 4, 4X, 5, 6, 6P, 12 (NEMA 250)	
Ambient temperature	Operating: -25 to +50°C (-13 to +122°F). Storage: -40 to +70°C (-40 to +158°F)			
CE marking	According to EN 60947-5-2			
Approvals	cULus (UL508)		cULus (UL508), ECOLAB	
Overvoltage category	III (IEC60664; EN 60947-1)			
Pollution degree	3 (EN60947-1)			
MTTF _d	138.5 years @ 40°C (104°F)			
Material	Body: ABS. Front glass: PMMA, red. Trimmer shaft: POM, grey.		Body: Stainless steel, AISI316L. Front glass: PPSU, red. Trimmer shaft: PEEK, light grey.	
Cable	PCV, black, 2 m, 4 x 0.14 mm ² , Ø=3.3 mm			
Connector	M8, 4-pin, male			
Dimensions	Cable and Plug: 10.8 x 30 x 20 mm		Cable and Plug: 11 x 31.5 x 21 mm	
Weight incl. packaging	Cable version ≤ 50 g, Plug version ≤ 20 g		Cable version ≤ 100 g, Plug version ≤ 65 g	
Accessories, additional	Connectors: CO...54NF...-series. Mounting brackets: APD30-MB1 or APD30-MB2		Connectors: CO...54NF...-W-series. Mounting brackets: APD30-MB1 or APD30-MB2	
Further informaion	www.gavazziautomation.com			



*) Stainless Steel sensors

PD30 series

IO-Link smart photoelectric sensors

PD30 photoelectric IO-Link Retro-reflective types

Housing	Plastic (ABS)		Stainless steel (AISI316L)	
	Plug	Cable	Plug	Cable
Red light (620 nm)	PD30CTRR60BPM5IO	PD30CTRR60BPBPA2IO	PD30ETRR60BPM5IO	PD30ETRR60BPBPA2IO
Red light Polarized (620 nm)	PD30CTPR60BPM5IO	PD30CTPR60BPBPA2IO	PD30ETPR60BPM5IO	PD30ETPR60BPBPA2IO
Red light Polarized + Pointspot (620 nm)	PD30CTPS50BPM5IO	PD30CTPS50BPBPA2IO	PD30ETPS50BPM5IO	PD30ETPS50BPBPA2IO
Sensing distance	PD30xTxR60: 1.7 ... 6 m; PD30xTPS50: 2.5 ... 5 m			
Rated operating distance (S _r)	PD30xTxR60: ≤ 6 m (ER4, Ø80), ≤ 4 m (ER4060); PD30xTPS50: ≤ 5 m (ER4, Ø80), ≤ 3 m (ER4060)			
IO-Link	Transmission type: COM2 (38.4 k Baud), Revision: 1.1, SDCI standard: IEC 61131-9, Profiles: Smart sensor (Process Data Variable; Device Identification), SIO mode: Yes, Required master port type: A, Min. process cycle time [ms]: 5			
Selectable function output 1	NPN, PNP or Push-Pull			
Selectable function output 2	NPN, PNP, Push-Pull, External input or External teach			
Diagnostic	Operation hours, Power cycles, Detection cycles max. and min. Temperatures, Short-circuit, No of Parameter change.			
Logic functions	AND, OR, X-OR, Gated SR-FF			
Timer functions	ON Delay, OFF delay, ON+OFF delay and One shot			
Sensitivity control	Trimmer input, Teach by wire or by IO-Link			
Rated operational voltage (U _B)	10 to 30 V DC (ripple included)			
No load supply current (I ₀)	≤ 30 mA @ U _B min, ≤ 15 mA @ U _B max			
Minimum operational current (I _m)	> 0.5 mA			
Off-State current (I ₀)	≤ 50 µA			
Voltage drop, digital (U _d)	≤ 1.0 V DC @ 100 mA DC			
Capacitive load	100 nF @ 100 mA, 24 VDC			
Frequency of operating cycles (f)	≤ 1000 Hz			
Response time t _{ON} or t _{OFF}	≤ 500 µs			
Power on delay (t _i)	≤ 150 ms			
Hysteresis (adjustable by IO-Link)	Manual: 1% - 100% Automatic: Typ. 5% - 10%/ Max. 15%			
Led indications	Yellow LED steady: Output ON and signal stability. Yellow LED flashing: Output short-circuit, timer indication and teach. Green LED steady: Power ON and signal stability. Green LED flashing: IO-Link mode. Yellow LED and green LED flashing: Find my sensor			
Sensor protection	Short circuit (A), reverse polarity (B) and transients (C)			
Electrostatic discharge	Contact discharge: ±4 kV. Air discharge: ±8 kV (IEC 61000-4-2; EN60947-1)			
Electrical fast transients/burst	±2kV/5kHz (IEC 61000-4-4; EN60947-1)			
Surge	1kV (with 500 Ω)			
Wire conducted disturbances	10 Vrms (IEC 61000-4-6; EN60947-1)			
Power - frequency magnetic fields	30 A/m, 38 µ tesla (IEC 61000-4-8)			
Radiated RF electromagnetic fields	10 V/m (IEC 61000-4-3)			
Vibration	10 to 150 Hz, 1 mm/15G in X,Y and Z direction (EN 60068-2-6)			
Shock	30G /11 mS. 3 positive and 3 negative in X,Y and Z direction (EN 60068-2-27)			
Drop test	2 times from 1m, 100 times from 0,5m (EN 60068-2-31)			
Degree of protection	IP67 (IEC60539; EN60947-1)		IP67, IP68, IP69K (IEC60539; EN60947-1; DIN40050-9)	
NEMA type	1 (NEMA 250)		1, 2, 4, 4X, 5, 6, 6P, 12 (NEMA 250)	
Ambient temperature	Operating: -25 to +60°C (-13 to +140°F). Storage: -40 to +85°C (-40 to +185°F)			
CE marking	According to EN 60947-5-2			
Approvals	cULus (UL508)		cULus (UL508), ECOLAB	
Overvoltage category	III (IEC60664; EN 60947-1)			
Pollution degree	3 (EN60947-1)			
MTTF _d	138.5 years @ 40°C (104°F)			
Material	Body: ABS. Front glass: PMMA, red. Trimmer shaft: POM, grey.		Body: Stainless steel, AISI316L. Front glass: PPSU, red. Trimmer shaft: PEEK, light grey.	
Cable	PCV, black, 2 m, 4 x 0.14 mm ² , Ø=3.3 mm			
Connector	M8, 4-pin, male			
Dimensions	Cable and Plug: 10.8 x 30 x 20 mm		Cable and Plug: 11 x 31.5 x 21 mm	
Weight incl. packaging	Cable version ≤ 50 g, Plug version ≤ 20 g		Cable version ≤ 100 g, Plug version ≤ 65 g	
Accessories, additional	Connectors: CO..54NF...-series. Mounting brackets: APD30-MB1 or APD30-MB2		Connectors: CO..54NF...W-series. Mounting brackets: APD30-MB1 or APD30-MB2	
Further informaion	www.gavazziautomation.com			



*) Stainless Steel sensors

Sensors

CARLO GAVAZZI Automation Components. Specifications are subject to change without notice. Illustrations are for example only.

PD30 photoelectric IO-Link Background suppression types

Housing	Plastic (ABS)		Stainless steel (AISI316L)	
	Plug	Cable	Plug	Cable
Infrared light (850 nm)	PD30CTBI20BPM5IO	PD30CTBI20BPA2IO	PD30ETBI20BPM5IO	PD30ETBI20BPA2IO
Red light (620 nm)	PD30CTBR20BPM5IO	PD30CTBR20BPA2IO	PD30ETBR20BPM5IO	PD30ETBR20BPA2IO
Red light long range (620 nm)	PD30CTBR35BPM5IO	PD30CTBR35BPA2IO	PD30ETBR35BPM5IO	PD30ETBR35BPA2IO
Red light pointspot (620 nm)	PD30CTBS25BPM5IO	PD30CTBS25BPA2IO	PD30ETBS25BPM5IO	PD30ETBS25BPA2IO
Sensing distance	PD30xTBx20: 25 ... 200 mm; PD30xTBR35: 25 ... 350 mm; PD30xTBS25: 25 ... 250 mm			
Rated operating distance (S _r)	PD30xTBx20: ≤ 200 mm; PD30xTBR35: ≤ 350 mm; PD30xTBS25: ≤ 250 mm			
IO-Link	Transmission type: COM2 (38.4 k Baud), Revision: 1.1, SDCI standard: IEC 61131-9, Profiles: Smart sensor (Process Data Variable; Device Identification), SIO mode: Yes, Required master port type: A, Min. process cycle time [ms]: 5			
Selectable function output 1	NPN, PNP or Push-Pull			
Selectable function output 2	NPN, PNP, Push-Pull, External input or External teach			
Diagnostic	Operation hours, Power cycles, Detection cycles max. and min. Temperatures, Short-circuit, No of Parameter change.			
Logic functions	AND, OR, X-OR, Gated SR-FF			
Timer functions	ON Delay, OFF delay, ON+OFF delay and One shot			
Sensitivity control	Trimmer input, Teach by wire or by IO-Link			
Rated operational voltage (U _s)	10 to 30 V DC (ripple included)			
No load supply current (I _s)	≤ 30 mA @ U _s min, ≤ 15 mA @ U _s max			
Minimum operational current (I _m)	> 0.5 mA			
Off-State current (I _o)	≤ 50 µA			
Voltage drop, digital (U _d)	≤ 1.0 V DC @ 100 mA DC			
Capacitive load	100 nF @ 100 mA, 24 VDC			
Frequency of operating cycles (f)	≤ 500 Hz			
Response time t _{ON} or t _{OFF}	≤ 1 ms			
Power on delay (t _i)	≤ 150 ms			
Hysteresis (adjustable by IO-Link)	Manual: PD30xTBx20: 2 ... 225 mm; PD30xTBS25: 2 ... 275 mm; PD30xTBR35: 2 ... 375 mm Automatic: PD30xTBx20: 14 mm (Factory settings (FS)); PD30xTBS25: 17 mm (FS); PD30xTBR35: 24 mm (FS)			
Led indications	Yellow LED steady: Output ON and signal stability. Yellow LED flashing: Output short-circuit, timer indication and teach. Green LED steady: Power ON and signal stability. Green LED flashing: IO-Link mode. Yellow LED and green LED flashing: Find my sensor			
Sensor protection	Short circuit (A), reverse polarity (B) and transients (C)			
Electrostatic discharge	Contact discharge: ±4 kV. Air discharge: ±8 kV (IEC 61000-4-2; EN60947-1)			
Electrical fast transients/burst	±2kV/5kHz (IEC 61000-4-4; EN60947-1)			
Surge	1kV (with 500 Ω)			
Wire conducted disturbances	10 Vrms (IEC 61000-4-6; EN60947-1)			
Power - frequency magnetic fields	30 A/m, 38 µ tesla (IEC 61000-4-8)			
Radiated RF electromagnetic fields	10 V/m (IEC 61000-4-3)			
Vibration	10 to 150 Hz, 1 mm/15G in X,Y and Z direction (EN 60068-2-6)			
Shock	30G /11 mS. 6 positive and 6 negative in X,Y and Z direction (EN 60068-2-27)			
Drop test	2 times from 1m, 100 times from 0,5m (EN 60068-2-31)			
Degree of protection	IP67 (IEC60539; EN60947-1)		IP67, IP68, IP69K (IEC60539; EN60947-1; DIN40050-9)	
NEMA type	1 (NEMA 250)		1, 2, 4, 4X, 5, 6, 6P, 12 (NEMA 250)	
Ambient temperature	Operating: -25 to +50°C (-13 to +122°F). Storage: -40 to +70°C (-40 to +158°F)			
CE marking	According to EN 60947-5-2			
Approvals	cULus (UL508)		cULus (UL508), ECOLAB	
Overvoltage category	III (IEC60664; EN 60947-1)			
Pollution degree	3 (EN60947-1)			
MTTF _a	138.5 years @ 40°C (104°F)			
Material	Body: ABS. Front glass: PMMA, red. Trimmer shaft: POM, grey.		Body: Stainless steel, AISI316L. Front glass: PPSU, red. Trimmer shaft: PEEK, light grey.	
Cable	PCV, black, 2 m, 4 x 0.14 mm ² , Ø=3.3 mm			
Connector	M8, 4-pin, male			
Dimensions	Cable and Plug: 10.8 x 30 x 20 mm		Cable and Plug: 11 x 31.5 x 21 mm	
Weight incl. packaging	Cable version ≤ 50 g, Plug version ≤ 20 g		Cable version ≤ 100 g, Plug version ≤ 65 g	
Accessories, additional	Connectors: CO..54NF...-series. Mounting brackets: APD30-MB1 or APD30-MB2		Connectors: CO..54NF...-W-series. Mounting brackets: APD30-MB1 or APD30-MB2	
Further informaion	www.gavazziautomation.com			



*) Stainless Steel sensors

CARLO GAVAZZI Automation Components. Specifications are subject to change without notice. Illustrations are for example only.

Further informaion: www.gavazziautomation.com

Sensors

OUR SALES NETWORK IN EUROPE

AUSTRIA

Carlo Gavazzi GmbH
Ketzergasse 374,
A-1230 Wien
Tel: +43 1 888 4112
Fax: +43 1 889 10 53
office@carlogavazzi.at

BELGIUM

Carlo Gavazzi NV/SA
Mechelsesteenweg 311,
B-1800 Vilvoorde
Tel: +32 2 257 4120
Fax: +32 2 257 41 25
sales@carlogavazzi.be

DENMARK

Carlo Gavazzi Handel A/S
Over Hadstenvej 40,
DK-8370 Hadsten
Tel: +45 89 60 6100
Fax: +45 86 98 15 30
handel@gavazzi.dk

FINLAND

Carlo Gavazzi OY AB
Ahventie, 4 B
FI-02170 Espoo
Tel: +358 9 756 2000
myynti@gavazzi.fi

FRANCE

Carlo Gavazzi Sarl
Zac de Paris Nord II, 69, rue de la Belle Etoile,
F-95956 Roissy CDG Cedex
Tel: +33 1 49 38 98 60
Fax: +33 1 48 63 27 43
french.team@carlogavazzi.fr

GERMANY

Carlo Gavazzi GmbH
Pfnorstr. 10-14
D-64293 Darmstadt
Tel: +49 6151 81000
Fax: +49 6151 81 00 40
info@gavazzi.de

GREAT BRITAIN

Carlo Gavazzi UK Ltd
4.4 Frimley Business Park,
Frimley, Camberley, Surrey GU16 7SG
Tel: +44 1 276 854 110
Fax: +44 1 276 682 140
sales@carlogavazzi.co.uk

ITALY

Carlo Gavazzi SpA
Via Milano, 13,
I-20045 Lainate
Tel: +39 02 931 761
Fax: +39 02 931 763 01
info@gavazziacbu.it

NETHERLANDS

Carlo Gavazzi BV
Wijkermeerweg 23,
NL-1948 NT Beverwijk
Tel: +31 251 22 9345
Fax: +31 251 22 60 55
info@carlogavazzi.nl

NORWAY

Carlo Gavazzi AS
Melkeveien 13,
N-3919 Parsgrunn
Tel: +47 35 93 0800
Fax: +47 35 93 08 01
posti@gavazzi.no

PORTUGAL

Carlo Gavazzi Lda
Rua dos Jerónimos 38-B,
P-1400-212 Lisboa
Tel: +351 21 361 7060
Fax: +351 21 362 13 73
carlogavazzi@carlogavazzi.pt

SPAIN

Carlo Gavazzi SA
Avda. Iparraguirre, 80-82,
E-48940 Leioa (Bizkaia)
Tel: +34 94 480 4037
Fax: +34 94 431 6081
gavazzi@gavazzi.es

SWEDEN

Carlo Gavazzi AB
V:a Kyrkogatan 1,
S-652 24 Karlstad
Tel: +46 54 85 1125
Fax: +46 54 85 11 77
info@carlogavazzi.se

SWITZERLAND

Carlo Gavazzi AG
Verkauf Schweiz/Vente Suisse
Sumpfstrasse 3,
CH-6312 Steinhausen
Tel: +41 41 747 4535
Fax: +41 41 740 45 40
info@carlogavazzi.ch

OUR SALES NETWORK IN THE AMERICAS

USA

Carlo Gavazzi Inc.
750 Hastings Lane,
Buffalo Grove, IL 60089, USA
Tel: +1 847 465 6100
Fax: +1 847 465 7373
sales@carlogavazzi.com

CANADA

Carlo Gavazzi Inc.
2660 Meadowvale Boulevard,
Mississauga, ON L5N 6M6, Canada
Tel: +1 905 542 0979
Fax: +1 905 542 22 48
gavazzi@carlogavazzi.com

MEXICO

Carlo Gavazzi Mexico S.A. de C.V.
Circuito Puericultores 22, Ciudad Satelite
Naucalpan de Juarez, Edo Mex. CP 53100
Mexico
T +52 55 5373 7042
F +52 55 5373 7042
mexicosales@carlogavazzi.com

BRAZIL

Carlo Gavazzi Automação Ltda.
Av. Francisco Matarazzo, 1752
Conj 2108 - Barra Funda - São Paulo/SP
Tel: +55 11 3052 0832
Fax: +55 11 3057 1753
info@carlogavazzi.com.br

OUR SALES NETWORK IN ASIA AND PACIFIC

SINGAPORE

Carlo Gavazzi Automation Singapore Pte. Ltd.
61 Tai Seng Avenue #05-06
Print Media Hub @ Paya Lebar iPark
Singapore 534167
Tel: +65 67 466 990
Fax: +65 67 461 980
info@carlogavazzi.com.sg

MALAYSIA

Carlo Gavazzi Automation (M) SDN. BHD.
D12-06-G, Block D12,
Pusat Perdagangan Dana 1,
Jalan PJU 1A/46, 47301 Petaling Jaya,
Selangor, Malaysia.
Tel: +60 3 7842 7299
Fax: +60 3 7842 7399
sales@gavazzi-asia.com

CHINA

Carlo Gavazzi Automation
(China) Co. Ltd.
Unit 2308, 23/F.,
News Building, Block 1, 1002
Middle Shennan Zhong Road,
Shenzhen, China
Tel: +86 755 83699500
Fax: +86 755 83699300
sales@carlogavazzi.cn

HONG KONG

Carlo Gavazzi Automation
Hong Kong Ltd.
Unit No. 16 on 25th Floor, One Midtown,
No. 11 Hoi Shing Road, Tsuen Wan,
New Territories, Hong Kong
Tel: +852 26261332 / 26261333
Fax: +852 26261316

TAIWAN

Branch of Carlo Gavazzi Automation
Singapore Pte. Ltd.
22F-1, No. 500 Shinzheng Rd,
Xitun Dist, Taichung City,
Taiwan, China
Tel. +886 4 2258 4001
Fax +886 4 22584 4002

OUR COMPETENCE CENTRES AND PRODUCTION SITES

DENMARK

Carlo Gavazzi Industri A/S
Hadsten

MALTA

Carlo Gavazzi Ltd
Zejtun

ITALY

Carlo Gavazzi Controls SpA
Belluno

LITHUANIA

Uab Carlo Gavazzi Industri Kaunas
Kaunas

CHINA

Carlo Gavazzi Automation (Kunshan) Co., Ltd.
Kunshan

HEADQUARTERS

Carlo Gavazzi Automation SpA
Via Milano, 13
I-20045 - Lainate (MI) - ITALY
Tel: +39 02 931 761
info@gavazziautomation.com

Energy to Components!

www.gavazziautomation.com